

HOLOGRAPHY, 1948-1971

Nobel Lecture, December 11, 1971

by

DENNIS GABOR

Imperial Colleges of Science and Technology, London

I have the advantage in this lecture, over many of my predecessors, that I need not write down a single equation or show an abstract graph. One can of course introduce almost any amount of mathematics into holography, but the essentials can be explained and understood from physical arguments.

Holography is based on the wave nature of light, and this was demonstrated convincingly for the first time in 1801 by Thomas Young, by a wonderfully simple experiment. He let a ray of sunlight into a dark room, placed a dark screen in front of it, pierced with two small pinholes, and beyond this, at some distance, a white screen. He then saw two darkish lines at both sides of a bright line, which gave him sufficient encouragement to repeat the experiment, this time with a spirit flame as light source, with a little salt in it, to produce the bright yellow sodium light. This time he saw a number of dark lines, regularly spaced; the first clear proof that light added to light can produce darkness. This phenomenon is called interference. Thomas Young had expected it because he believed in the wave theory of light. His great contribution to Christian Huygens's original idea was the intuition that mono-

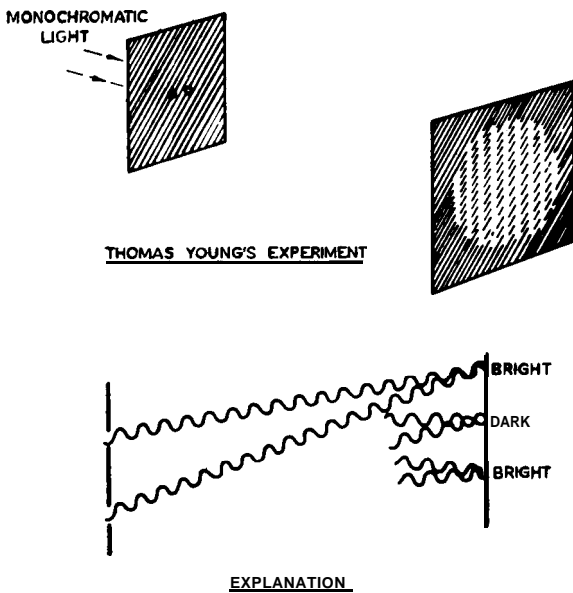

Fig. 1.
Thomas Young's Interference Experiments, 1801

chromatic light represents regular, sinusoidal oscillations, in a medium which at that time was called "the ether". If this is so, it must be possible to produce more light by adding wavecrest to wavecrest, and darkness by adding wavecrest to wavethrough.

Light which is capable of interferences is called "coherent", and it is evident that in order to yield many interference fringes, it must be very monochromatic. Coherence is conveniently measured by the path difference between two rays of the same source, by which they can differ while still giving observable interference contrast. This is called the coherence length, an important quantity in the theory and practice of holography. Lord Rayleigh and Albert Michelson were the first to understand that it is a reciprocal measure of the spectroscopic line width. Michelson used it for ingenious methods of spectral analysis and for the measurement of the diameter of stars.

Let us now jump a century and a half, to 1947. At that time I was very interested in electron microscopy. This wonderful instrument had at that time produced a hundredfold improvement on the resolving power of the best light microscopes, and yet it was disappointing, because it had stopped short of resolving atomic lattices. The de Broglie wavelength of fast electrons, about $1/20$ Ångström, was short enough, but the optics was imperfect. The best electron objective which one can make can be compared in optical perfection to a raindrop than to a microscope objective, and through the theoretical work of O. Scherzer it was known that it could never be perfected. The theoretical limit at that time was estimated at 4 Å, just about twice what was

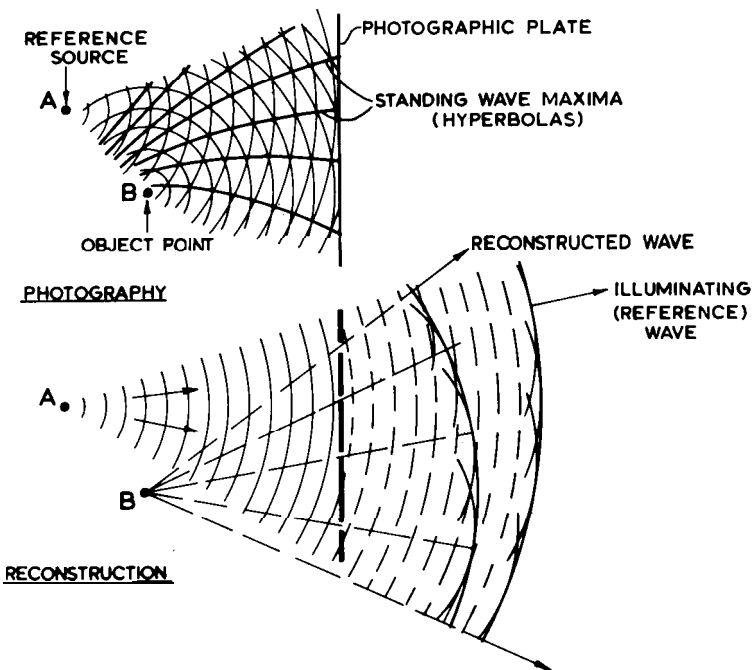

Fig. 2.
The Basic Idea of Holography, 1947.

needed to resolve atomic lattices, while the practical limit stood at about 12 \AA . These limits were given by the necessity of restricting the aperture of the electron lenses to about $5/1000$ radian, at which angle the spherical aberration error is about equal to the diffraction error. If one doubles this aperture so that the diffraction error is halved, the spherical aberration error is increased 8 times, and the image is hopelessly blurred.

After pondering this problem for a long time, a solution suddenly dawned on me, one fine day at Easter 1947, more or less as shown in Figure 2. Why not take a bad electron picture, but one which contains the *whole* information, and correct it by optical means? It was clear to me for some time that this could be done, if at all, only with coherent electron beams, with electron waves which have a definite phase. But an ordinary photograph loses the phase completely, it records only the intensities. No wonder we lose the phase, if there is nothing to compare it with! Let us see what happens if we add a standard to it, a "coherent background". My argument is illustrated in Figure 2, for the simple case when there is only one object point. The interference of the object wave and of the coherent background or "reference wave" will then produce interference fringes. There will be maxima wherever the phases of the two waves were identical. Let us make a hard positive record, so that it transmits only at the maxima, and illuminate it with the reference source alone. Now the phases are of course right for the reference source A, but as at the slits the phases are identical, they must be right also for B; therefore the wave of B must also appear, *reconstructed*.

A little mathematics soon showed that the principle was right, also for more than one object point, for any complicated object. Later on it turned out that in holography Nature is on the inventor's side; there is no need to take a hard positive record; one can take almost any negative. This encouraged me to complete my scheme of electron microscopy by reconstructed wavefronts, as I then called it and to propose the two-stage process shown in Figure 3. The electron microscope was to produce the interference figure between the object beam and the coherent background, that is to say the non-diffracted part of the illuminating beam. This interference pattern I called a "hologram", from the Greek word "holos"-the whole, because it contained the whole information. The hologram was then reconstructed with light, in an optical system which corrected the aberrations of the electron optics (1).

In doing this, I stood on the shoulders of two great physicists, W. L. Bragg and Frits Zernike. Bragg had shown me, a few years earlier, his "X-ray microscope" an optical Fourier-transformer device. One puts into it a small photograph of the reciprocal lattice, and obtains a projection of the electron densities, but only in certain exceptional cases, when the phases are all real, and have the same sign. I did not know at that time, and neither did Bragg, that Mieczslav Wolfke had proposed this method in 1920, but without realising it experimentally.¹ So the idea of a two-stage method was inspired by Bragg. The coherent background, on the other hand, was used with great success by Frits

¹M. Wolfke, Phys. Zeits. 21, 495-7, Sept. 15, 1920.

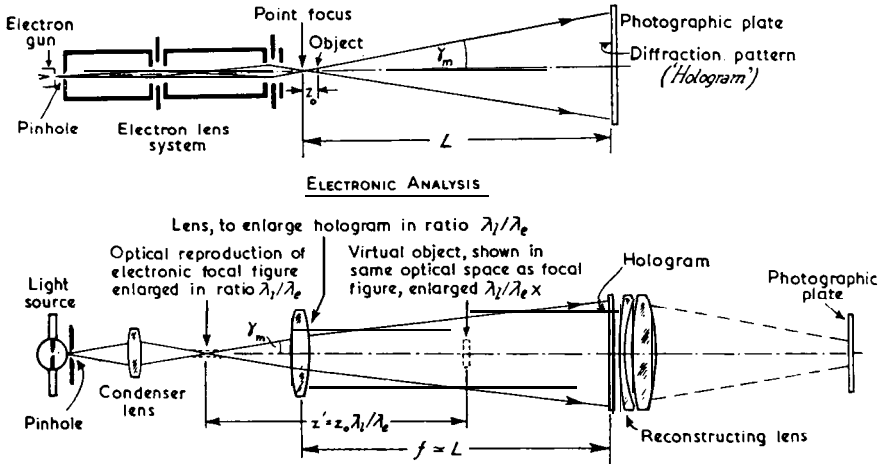

Fig. 3. The Principle of Electron Microscopy by Reconstructed Wavefronts (Gabor, Proc. Royal Society, A, 197, 454, 1949).

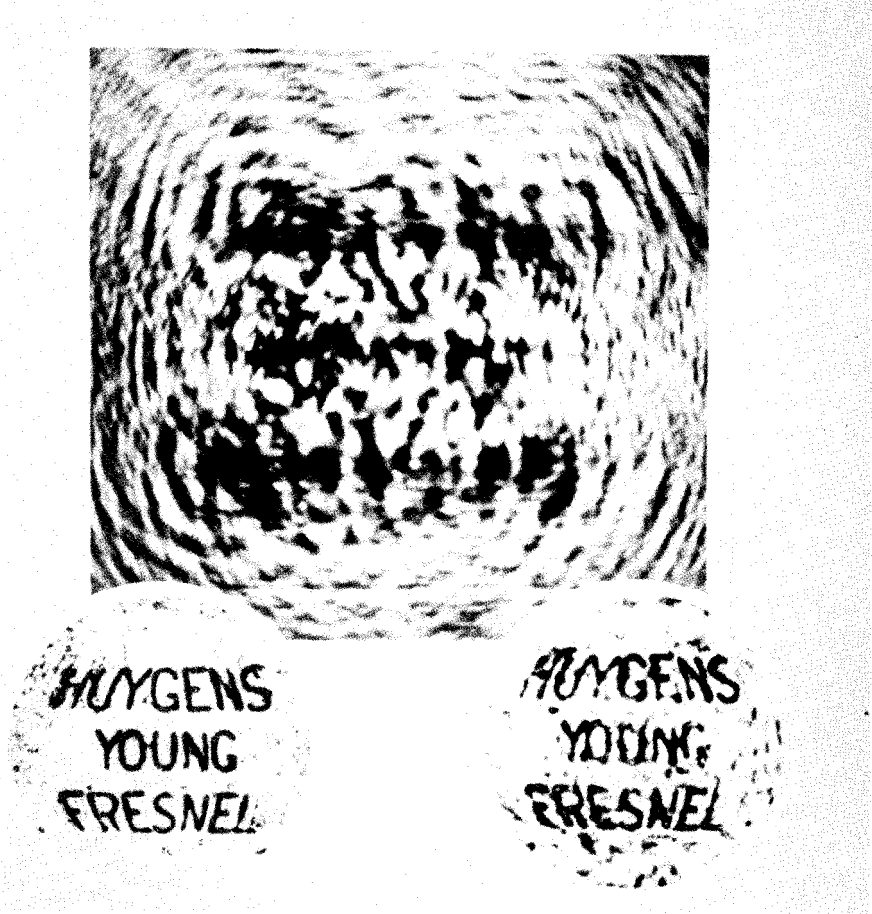

Fig 4. First Holographic Reconstruction, 1948

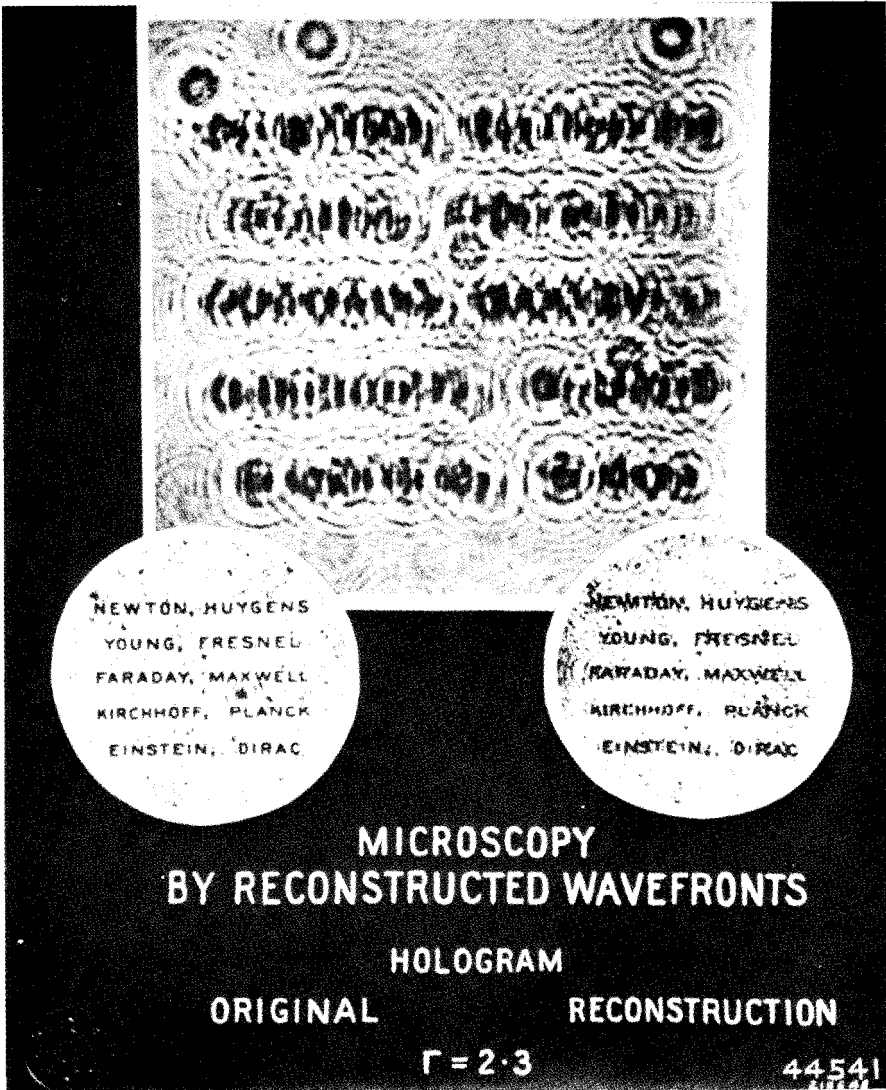

Fig. 5.
Another Example of Early Holography, 1948 (Gabor, Proc. Roy. Soc. A, 197, 454, 1949).

Zernike in his beautiful investigations on lens aberrations, showing up their phase, and not just their intensity. It was only the reconstruction principle which had escaped them.

In 1947 I was working in the Research Laboratory of the British Thomson-Houston Company in Rugby, England. It was a lucky thing that the idea of holography came to me via electron microscopy, because if I had thought of optical holography only, the Director of Research, L. J. Davies, could have objected that the BTH company was an electrical engineering firm, and not in the optical field. But as our sister company, Metropolitan Vickers were makers of electron microscopes, I obtained the permission to carry out some

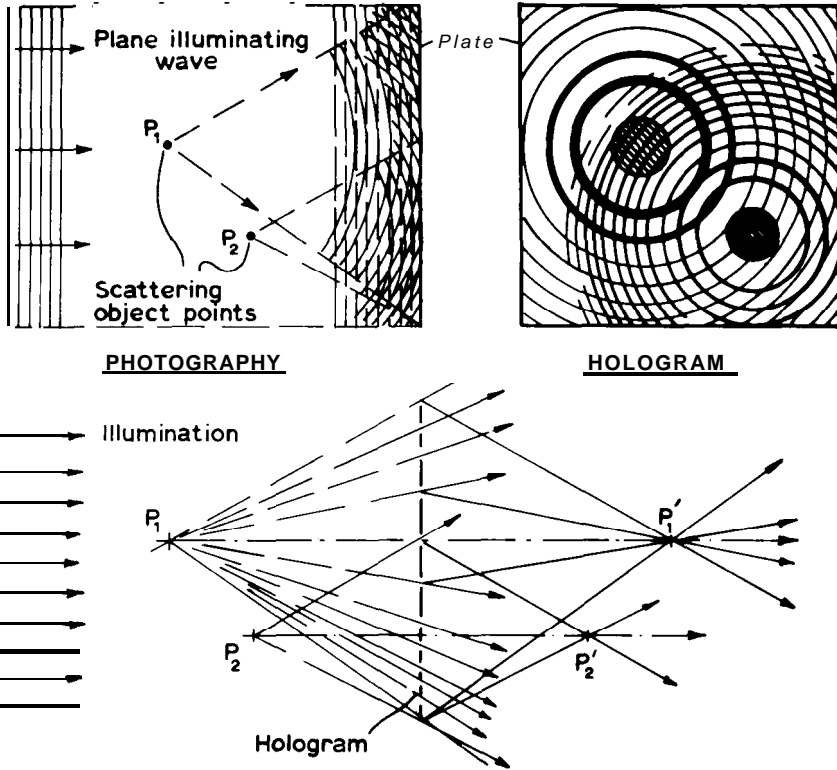

Fig. 6. The Second Image. Explanation in Terms of Soret-lenses as Holograms of Single Object Points.

optical experiments. Figure 4 shows one of our first holographic reconstructions. The experiments were not easy. The best compromise between coherence and intensity was offered by the high pressure mercury lamp, which had a coherence length of only 0.1 mm, enough for about 200 fringes. But in order to achieve spatial coherence, we (my assistant Ivor Williams and I) had to illuminate, with one mercury line, a pinhole of 3 microns diameter. This left us with enough light to make holograms of about 1 cm diameter of objects, which were microphotographs of about 1 mm diameter, with exposures of a few minutes, on the most sensitive emulsions then available. The small coherence length forced us to arrange everything in one axis. This is now called "in line" holography, and it was the only one possible at that time. Figure 5 shows a somewhat improved experiment, the best of our series. It was far from perfect. Apart from the *schlieren*, which cause random disturbances, there was a systematic defect in the pictures, as may be seen by the distortion of the letters. The explanation is given in Figure 6. The disturbance arises from the fact that there is not one image but two. Each point of the object emits a spherical secondary wave, which interferes with the background and produces a system of circular Fresnel zones. Such a system is known after the optician who first produced it, a Soret lens. This is, at the same time, a positive and a

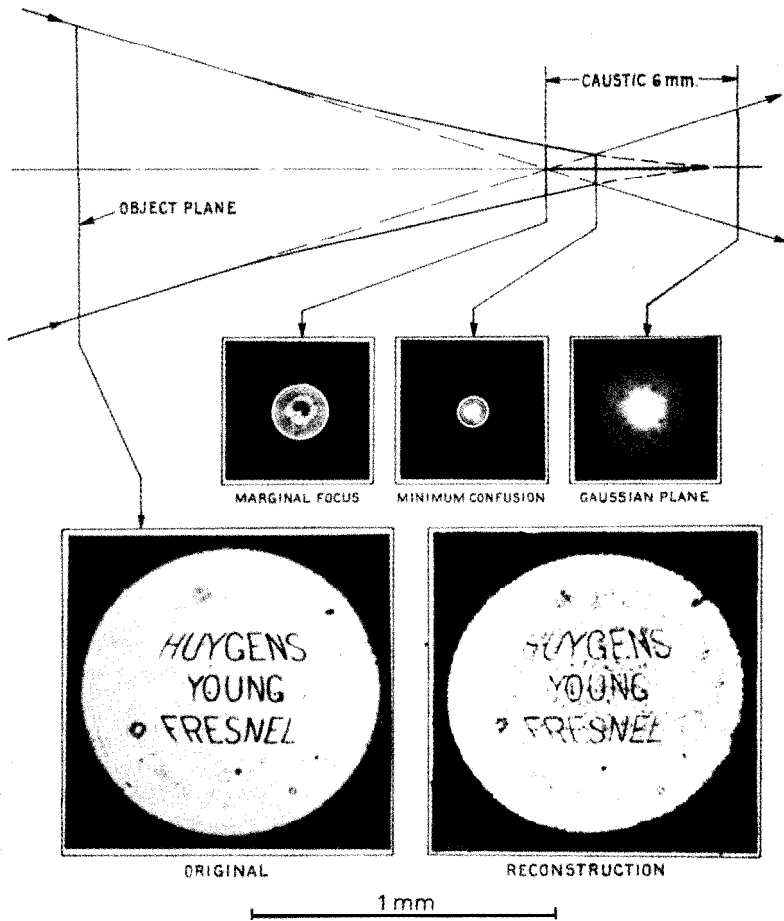

Fig. 7.

Elimination of the Second Image, by Compensation of the Spherical Aberration in the Reconstruction (Gabor, 1948; published 1951).

negative lens. One of its foci is in the original position of the object point, the other in a position conjugate to it, with respect to the illuminating wavefront. If one uses "in-line holography" both images are in line, and can be separated only by focusing. But the separation is never quite perfect, because in regular, coherent illumination every point leaves a "wake" behind it, which reaches to long distances.

I will tell later with what ease modern laser holography has got rid of this disturbance, by making use of the superior coherence of laser light which was not at my disposal in 1948. However, I was confident that I could eliminate the second image in the application which alone interested me at that time: seeing atoms with the electron microscope. This method, illustrated in Figure 7, utilized the very defect of electron lenses, the spherical aberration, in order to defeat the second image. If an electron hologram is taken with a lens with spherical aberration, one can afterwards correct *one* of the two images by

suitable optics, and the other has then twice the aberration, which washes it out almost completely. Figure 7 shows that a perfectly sharp reconstruction, in which as good as nothing remains of the disturbance caused by the second image, can be obtained with a lens so bad that its definition is at least 10 times worse than the resolution which one wants to obtain. Such a very bad lens was obtained using a microscope objective the wrong way round, and using it again in the reconstruction.

So it was with some confidence that two years later, in 1950 we started a programme of holographic electron microscopy in the Research Laboratory of the Associated Electrical Industries, in Aldermaston, under the direction of Dr T. E. Allibone, with my friends and collaborators M. W. Haine, J. Dyson and T. Mulvey. ²By that time I had joined Imperial College, and took part in the work as a consultant. In the course of three years we succeeded in considerably improving the electron microscope, but in the end we had to give up, because we had started too early. It turned out that the electron microscope was still far from the limit imposed by optical aberrations. It suffered from vibrations, stray magnetic fields, creep of the stage, contamination of the object, all made worse by the long exposures required in the weak coherent electron beam. Now, 20 years later, would be the right time to start on such a programme, because in the meantime the patient work of electron microscopists has overcome all these defects. The electron microscope resolution is now right up to the limit set by the spherical aberration, about 3.5 \AA , and only an improvement by a factor of 2 is needed to resolve atomic lattices. Moreover, there is no need now for such very long exposures as we had to contemplate in 1951, because by the development of the field emission cathode the coherent current has increased by a factor of 3-4 orders of magnitude. So perhaps I may yet live to see the realisation of my old ideas.

My first papers on wavefront reconstruction evoked some immediate responses. G. L. Rogers (2) in Britain made important contributions to the technique, by producing among other things the first phase holograms, and also by elucidating the theory. In California Alberto Baez (3) Hussein El-Sum and P. Kirckpatrick (4) made interesting forays into X-ray holography. For my part, which my collaborator W. P. Goss, I constructed a holographic interference microscope, in which the second image was annulled in a rather complicated way by the superimposition of two holograms, "in quadrature" with one another. The response of the optical industry to this was so disappointing that we did not publish a paper on it until 11 years later, in 1966 (5). Around 1955 holography went into a long hibernation.

The revival came suddenly and explosively in 1963, with the publication of the first successful laser" holograms by Emmett N. Leith and Juris Upatnieks

²Supported by a grant of the D.S.I.R. (Direction of Scientific and Industrial Research) the first research grant ever given by that body to an industrial laboratory.

³I have been asked more than once why I did not invent the laser. In fact, I have thought of it. In 1950, thinking of the desirability of a strong source of coherent light, I remembered that in 1921, as a young student, in Berlin, I had heard from Einstein's own lips his wonderful derivation of Planck's law which postulated the existence of

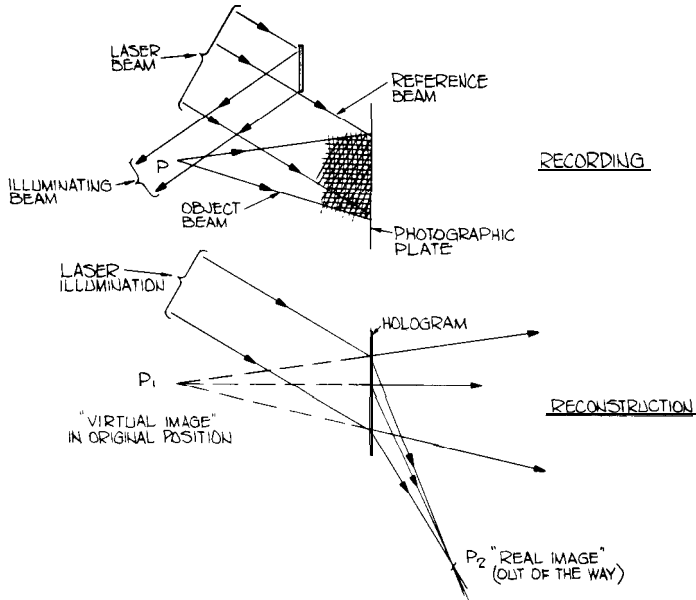

Fig. 8.
Holography with Skew Reference Beam. E. N. Leith and J. Upatnieks, 1963.

of the University of Michigan, Ann Arbor. Their success was due not only to the laser, but to the long theoretical preparation of Emmett Leith, which started in 1955. This was unknown to me and to the world, because Leith, with his collaborators Cutrona, Palermo, Porcello and Vivian applied his ideas first to the problem of the "side-looking radar" which at that time was classified (6). This was in fact two-dimensional holography with electromagnetic waves, a counterpart of electron holography. The electromagnetic waves used in radar are about 100,000 times longer than light waves, while electron waves are about 100,000 times shorter. Their results were brilliant, but to my regret I cannot discuss them for lack of time.

When the laser became available, in 1962, Leith and Upatnieks could at once produce results far superior to mine, by a new, simple and very effective method of eliminating the second image (7). This is the method of the "skew reference wave", illustrated in Figure 8. It was made possible by the great coherence length of the helium-neon laser, which even in 1962 exceeded that of the mercury lamp by a factor of about 3000. This made it possible to separate the reference beam from the illuminating beam; instead of going through the object, it could now go around it. The result was that the two reconstructed images were now separated not only in depth, but also angularly, by twice the incidence angle of the reference beam. Moreover, the intensity of

stimulated emission. I then had the idea of the pulsed laser: Take a suitable crystal, make a resonator of it by a highly reflecting coating, fill up the upper level by illuminating it through a small hole, and discharge it explosively by a ray of its own light. I offered the idea as a Ph.D. problem to my best student, but he declined it, as too risky, and I could not gainsay it, as I could not be sure that we would find a suitable crystal.



Fig. 9.

First Example of Multiple Image Storage in One Hologram. E. N. Leith and J. Upatnieks, *Journal of Optical Society of America*, November 1964.

the coherent laser light exceeded that of mercury many millionfold. This made it possible to use very fine-grain, low speed photographic emulsions and to produce large holograms, with reasonable exposure times.

Figure 9 shows two of the earliest reconstructions made by Leith and Upatnieks, in 1963, which were already greatly superior to anything that I could produce in 1948. The special interest of these two images is, that they are reconstructions from one hologram, taken with different positions of the reference beam. This was the first proof of the superior storage capacity of

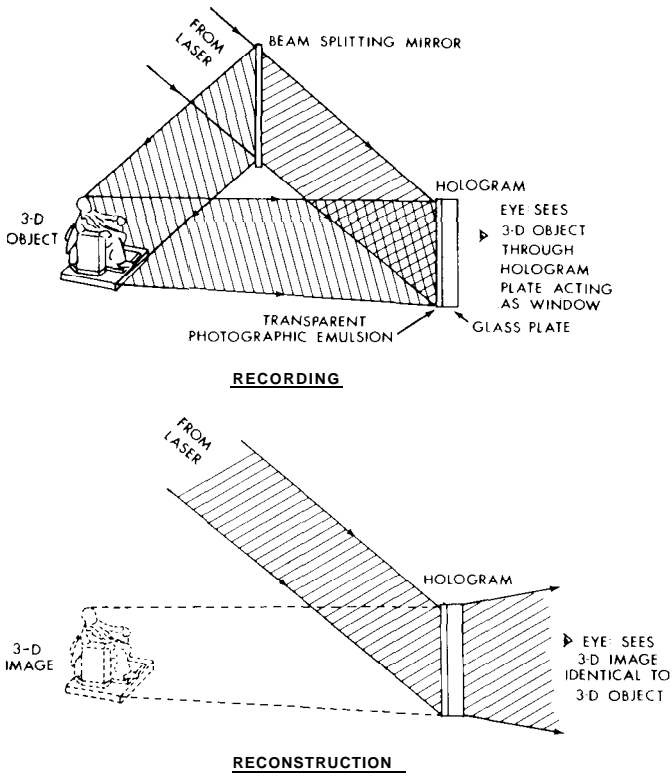

Fig. 10.
3-D Holography of a Diffusing Object with Laser Light.

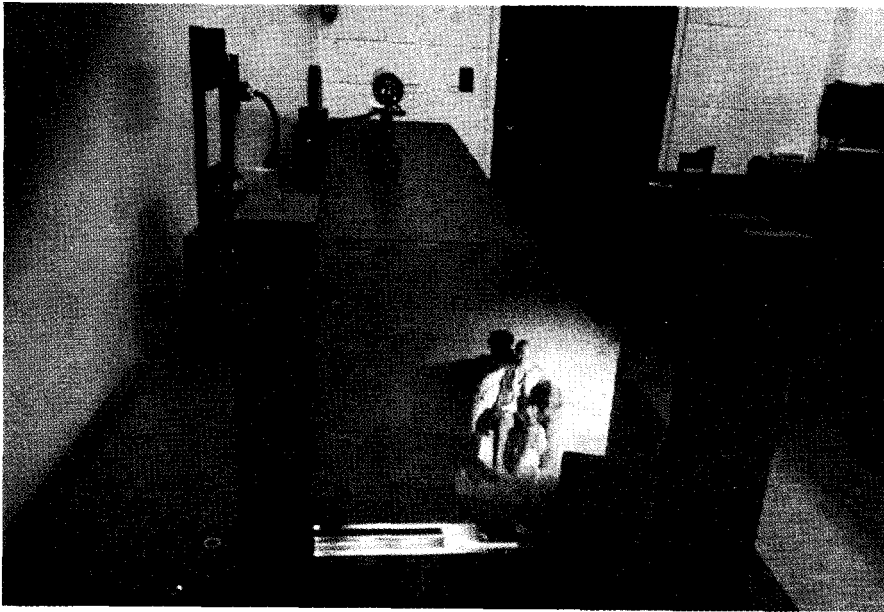

Fig. 11.
Three dimensional Reconstruction of a Small Statue of Abraham Lincoln. (Courtesy of Professor G. W. Stroke, State University of New York, Stony Brook).

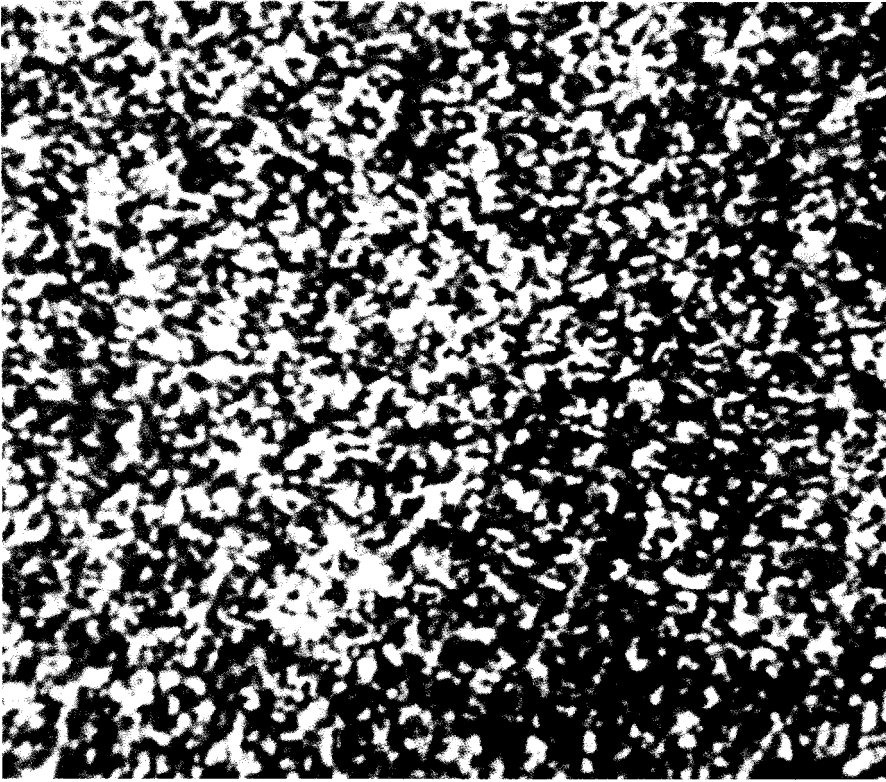

Fig. 12.
Strongly Magnified Image of a Hologram taken with Diffused Illumination. The Information is conveyed in a noiselike code. E. N. Leith and J. Upatnieks, 1964.

holograms. Leith and Upatnieks could soon store 12 different pictures in one emulsion. Nowadays one can store 100 or even 300 pages of printed matter in an area which by ordinary photography would be sufficient for one.

From then on progress became very rapid. The most spectacular result of the first year was the holography of three dimensional objects, which could be seen with two eyes. Holography was of course three dimensional from the start, but in my early, small holograms one could see this only by focusing through the field with a microscope or short-focus eyepiece. But it was not enough to make the hologram large, it was also necessary that every point of the photographic plate should see every point of the object. In the early holograms, taken with regular illumination, the information was contained in a small area, in the diffraction pattern.

In the case of rough, diffusing objects no special precautions are necessary. The small dimples and projections of the surface diffuse the light over a large cone. Figure 10 shows an example of the setup in the case of a rough object, such as a statuette of Abraham Lincoln. The reconstruction is shown in Figure 11. With a bleached hologram ("phase hologram") one has the impression of looking through a clear window at the statuette itself.

If the object is non-diffusing, for instance if it is a transparency, the information is spread over the whole hologram area by illuminating the object through a diffuser, such as a frosted glass plate. The appearance of such a "diffused" hologram is extraordinary; it looks like noise. One can call it "ideal Shannon coding", because Claude E. Shannon has shown in his Communication Theory that the most efficient coding is such that all regularities seem to have disappeared in the signal: it must be "noise-like". But where is the information in this chaos? It can be shown that it is not as irregular as it appears. It is not as if grains of sand had been scattered over the plate at random. It is rather a complicated figure, the diffraction pattern of the object, which is repeated at random intervals, but always in the same size and same orientation.

A very interesting and important property of such diffused holograms is that any small part of it, large enough to contain the diffraction pattern, contains information on the whole object, and this can be reconstructed from the fragment, only with more noise. A diffuse hologram is therefore *a distributed memory*, and this was evoked much speculation whether human memory is not perhaps, as it were, holographic, because it is well known that a good part of the brain can be destroyed without wiping out every trace of a memory. There is no time here to discuss this very exciting question. I want only to say that in my opinion the similarity with the human memory is functional only, but certainly not structural.

It is seen that in the development of holography the hologram has become always more unlike the object, but the reconstruction always more perfect. Figure 13 shows an excellent reconstruction by Leith and Upatnieks of a



Fig. 13. Reconstruction of a Plane Transparency, Showing a Restaurant, from a Hologram taken with Diffused Illuminations (E. N. Leith and J. Upatnieks, 1964).

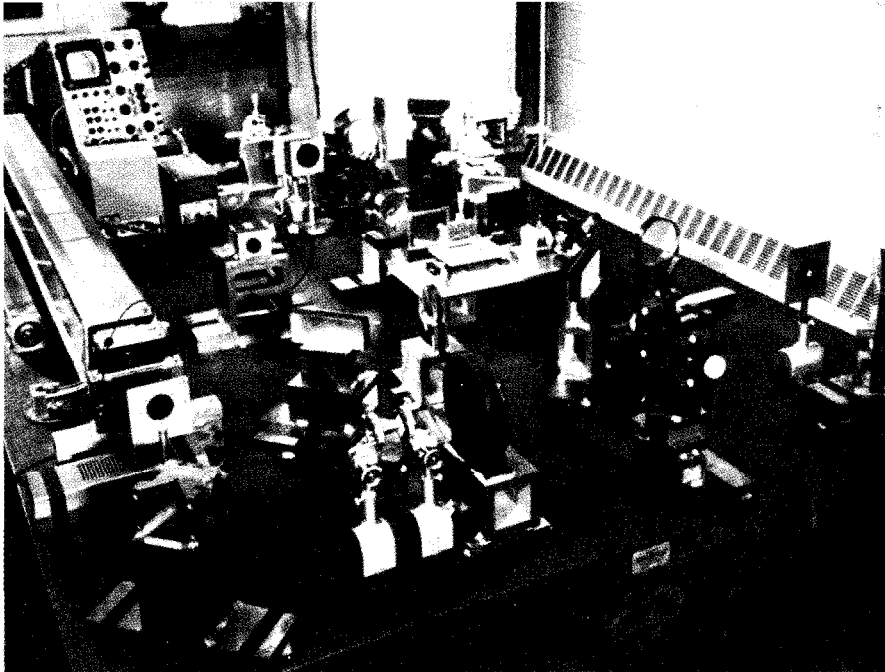

Fig. 14.
Modern Holographic Equipment.

photograph, from a diffuse hologram like the one in the previous figure.

The pioneer work carried out in the University of Michigan, Ann Arbor, led also to the stabilization of holographic techniques. Today hundreds if not thousands of laboratories possess the equipment of which an example is shown in Figure 14; the very stable granite slab or steel table, and the various optical devices for dealing with coherent light, which are now manufactured by the optical industry. The great stability is absolutely essential in all work carried out with steady-state lasers, because a movement of the order of a quarter wavelength during the exposure can completely spoil a hologram.

However, from 1965 onwards there has developed an important branch of holography where high stability is not required, because the holograms are taken in a small fraction of a microsecond, with a pulsed laser.

Imagine that you had given a physicist the problem: "Determine the size of the droplets which issue from a jet nozzle, with a velocity of 2 Mach. The sizes are probably from a few microns upwards." Certainly he would have thrown up his hands in despair! But all it takes now, is to record a simple in-line hologram of the jet, with the plate at a safe distance, with a ruby laser pulse of 20-30 nanoseconds. One then looks at the "real" image (or one reverses the illuminating beam and makes a real image of the virtual one), one dives with a microscope into the three-dimensional image of the jet and focuses the particles, one after the other. Because of the large distance, the disturbance by the second image is entirely negligible. Figure 15 shows a fine example.

As the research workers of the TRW laboratories have shown, it is possible

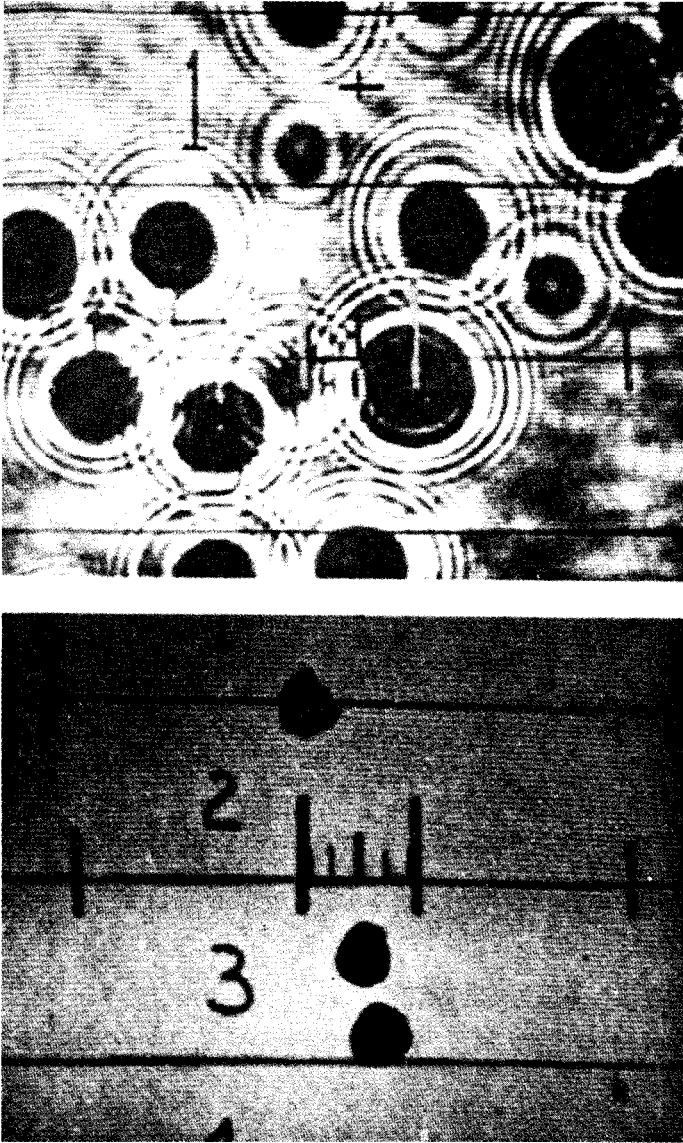

Fig. 15.
Holography of Jets. (Courtesy of Laser Holography Inc., Santa Barbara, California.)

to record in one hologram the infusoriae in several feet of dirty water, or insects in a meter of air space. Figure 16 shows two reconstructions of insects from one hologram, focusing on one after the other. The authors, C. Knox and R. E. Brooks, have also made a cinematographic record of a holographic film, in which the flight of one mosquito is followed through a considerable depth, by refocusing in every frame (9).

Another achievement of the TRW group, Ralph Wuerker and his colleagues, leads us into another branch of holography, to holographic interferometry. Figure 17 shows a reconstruction of a bullet, with its train of shockwaves, as

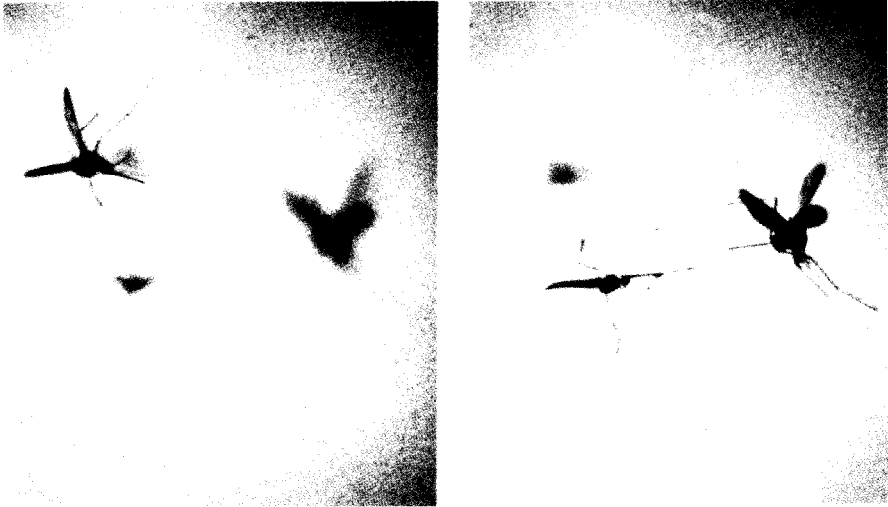

Fig. 16.
Observation of Mosquitos in Flight. Both Pictures are extracted from one Hologram.
(Courtesy of C. Knox and R. E. Brooks, TRW, Redondo Beach, California.)

it meets another shockwave. But it is not just an image, it is an interferometric image. The fringes show the *loci* at which the retardation of light is by integer wavelengths, relative to the quiet air, before the event. This comparison standard is obtained by a previous exposure. This is therefore a double-exposure hologram, such as will be discussed in more detail later (10).

Figure 18 shows another high achievement of pulse holography: a holographic, three-dimensional portrait, obtained by L. Siebert in the Conductron Corporation (now merged into McDonnell-Douglas Electronics Company, St Charles, Missouri). It is the result of outstanding work in the development of lasers. The ruby laser, as first realised by T. H. Maiman, was capable of short pulses, but its coherence length was of the order of a few cm only. This is no obstacle in the case of in-line holography, where the reference wave proceeds almost in step with the diffracted wavelets, but in order to take a scene of, say, one meter depth with reflecting objects one must have a coherence length of at least one meter. Nowadays single-mode pulses of 30 nanosecond duration with 10 joule in the beam and coherence lengths of 5-8 meters are available, and have been used recently for taking my holographic portrait shown in the exhibition attached to this lecture.

In 1965 R. L. Powell and K. A. Stetson in the University of Michigan, Ann Arbor, made an interesting discovery. Holographic images taken of moving objects are washed out. But if double exposure is used, first with the object at rest, then in vibration, fringes will appear, indicating the lines where the displacement amounted to multiples of a half wavelength. Figure 19 shows vibrational modes of a loudspeaker membrane, recorded in 1965 by Powell and Stetson (11), Figure 20 the same for a guitar, taken by H. A. Stetson in the laboratory of Professor Erik Ingelstam (12).

Curiously, both the interferograms of the TRW group and the vibrational



Fig. 17.
Dynamic Holographic Interferometry. This Reconstruction of a Holographic Interferogram shows the interaction of two air shock fronts and their associated flows. (Courtesy of Dr R. F. Wuerker and his associates, TRW Physical Electronics Laboratory, Redondo Beach, Calif.)

records of Powell and Stetson preceded what is really a simpler application of the interferometrical principle, and which historically ought to have come first - if the course of science would always follow the shortest line. This is the observation of small deformations of solid bodies, by double exposure holograms. A simple explanation is as follows: We take a hologram of a body in State A. This means that we freeze in the wave A by means of a reference beam. Now let us deform the body so that it assumes the State B and take a second hologram in the same emulsion with the same reference beam. We develop the hologram, and illuminate it with the reference beam. Now the two waves A and B, frozen in at different times, and which have never seen one another, will be revived simultaneously, and they interfere with one an-

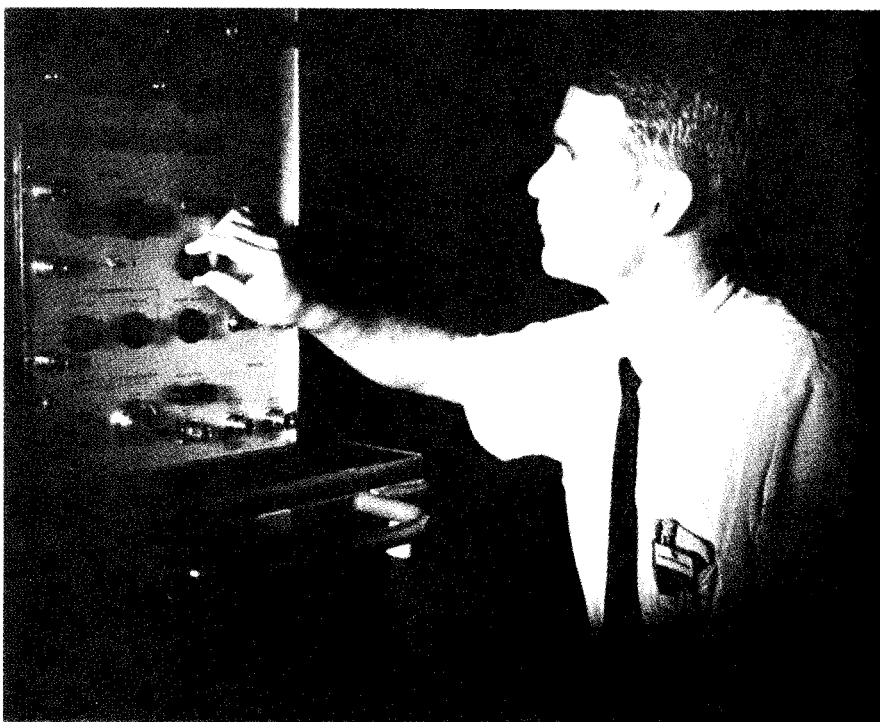

Fig. 18.
Holographic Portrait. (I. Siebert, Conductron Corporation, now merged into McDonnell-Douglas Electronics Company, St Charles, Missouri.)

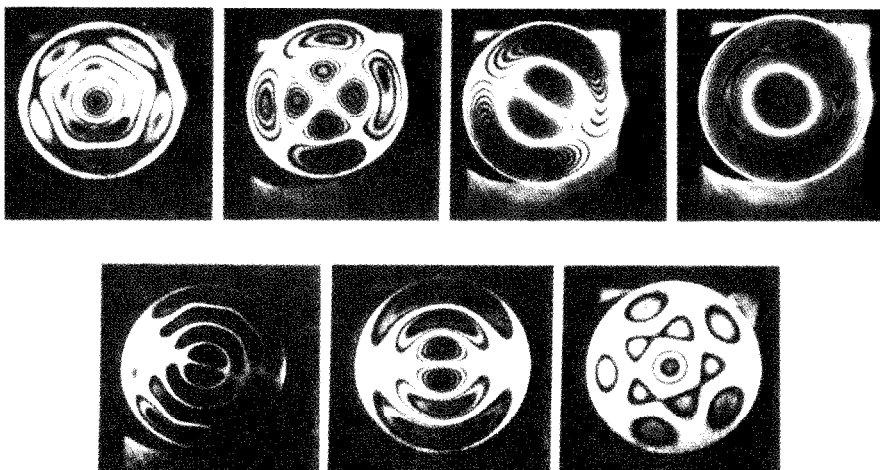

Fig. 19.
Vibrational Modes of a Loudspeaker diaphragm, obtained by Holographic Interferometry. (R. L. Powell and K. A. Stetson, University of Michigan, Ann Arbor, 1965.)

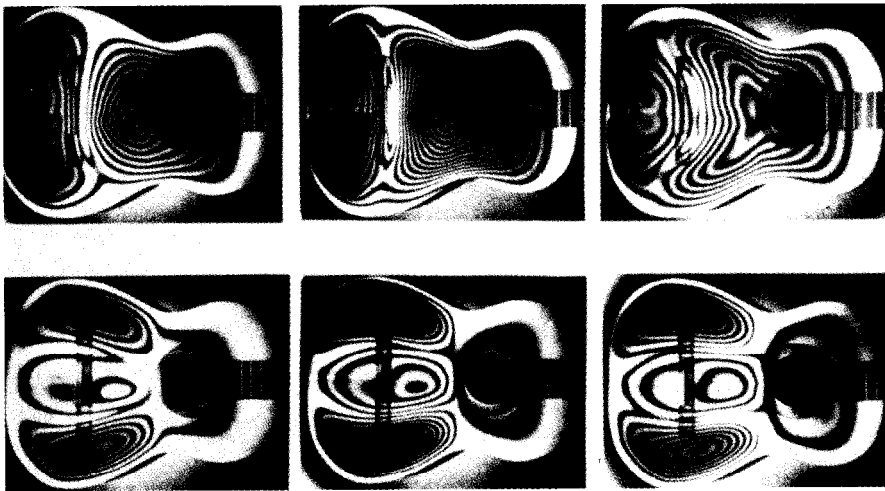

Fig. 20.
Vibrational Modes of a Guitar, Recorded by Holographic Interferometry. (Courtesy of Dr K. A. Stetson and Professor E. Ingelstarn.)

other. The result is that Newton fringes will appear on the object, each fringe corresponding to a deformation of a half wavelength. Figure 21 shows a fine example of such a holographic interferogram, made in 1965 by Haines and Hillebrand. The principle was discovered simultaneously and independently also by J. M. Burch in England, and by G. W. Stroke and A. Labeyrie in Ann

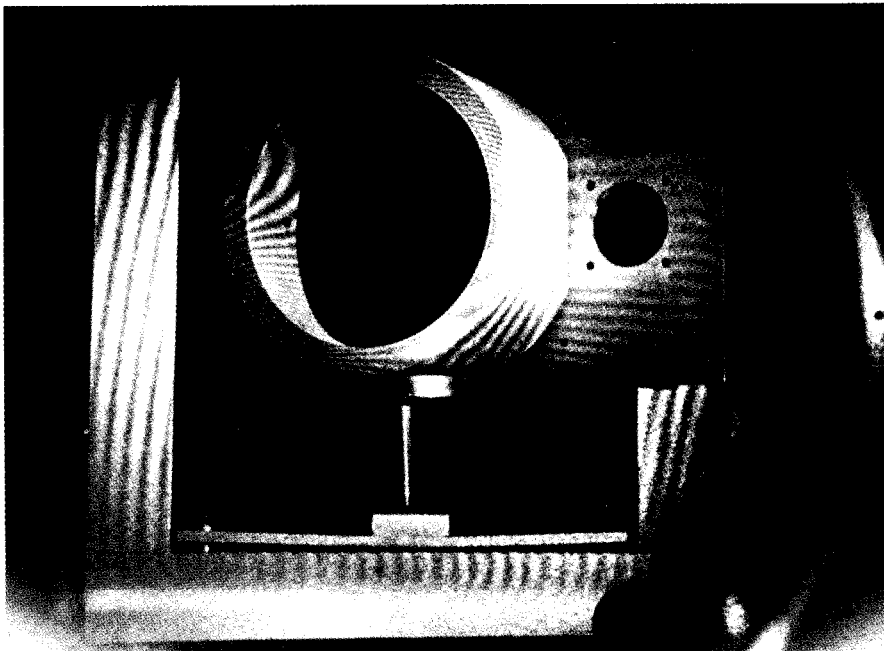

Fig. 21.
An early Example of Holographic Interferometry by Double Exposure. (Haines and Hildebrand, University of Michigan, Ann Arbor, 1965.)

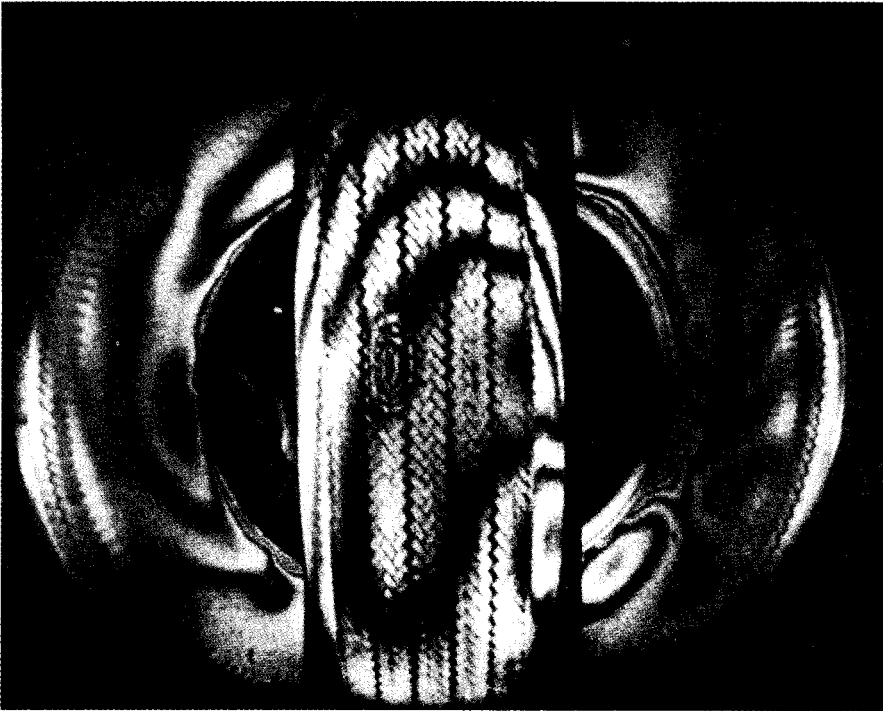

Fig. 22.
Non-destructive Testing by Holography. Double Exposure Hologram, revealing two flaws in a tyre (Courtesy of Dr Ralph Grant and GCO, Ann Arbor, Michigan).

Arbor, Michigan.

Non-destructive testing by holographic interferometry is now by far the most important industrial application of holography. It gave rise to the first industrial firm based on holography, GCO (formerly G. C. Optronics), in Ann Arbor, Michigan, and the following examples are reproduced by courtesy of GCO. Figure 22 shows the testing of a motor car tyre. The front of the tyre is holographed directly, the sides are seen in two mirrors, right and left. First a little time is needed for the tyre to settle down and a first hologram is taken. Then a little hot air is blown against it, and a second exposure is made, on the same plate. If the tyre is perfect, only a few, widely spaced fringes will appear, indicating almost uniform expansion. But where the cementing of the rubber sheets was imperfect, a little blister appears, as seen near the centre and near the top left corner, only a few thousandths of a millimeter high, but indicating a defect which could become serious. Alternatively, the first hologram is developed, replaced exactly in the original position, and the expansion of the tyre is observed "live".

Other examples of non-destructive testing are shown in Figure 23; all defects which are impossible or almost impossible to detect by other means, but which reveal themselves unmistakably to the eye. A particularly impressive piece of equipment manufactured by GCO is shown in Figure 24. It is a holographic analyser for honeycomb sandwich structures (such as shown in the middle of

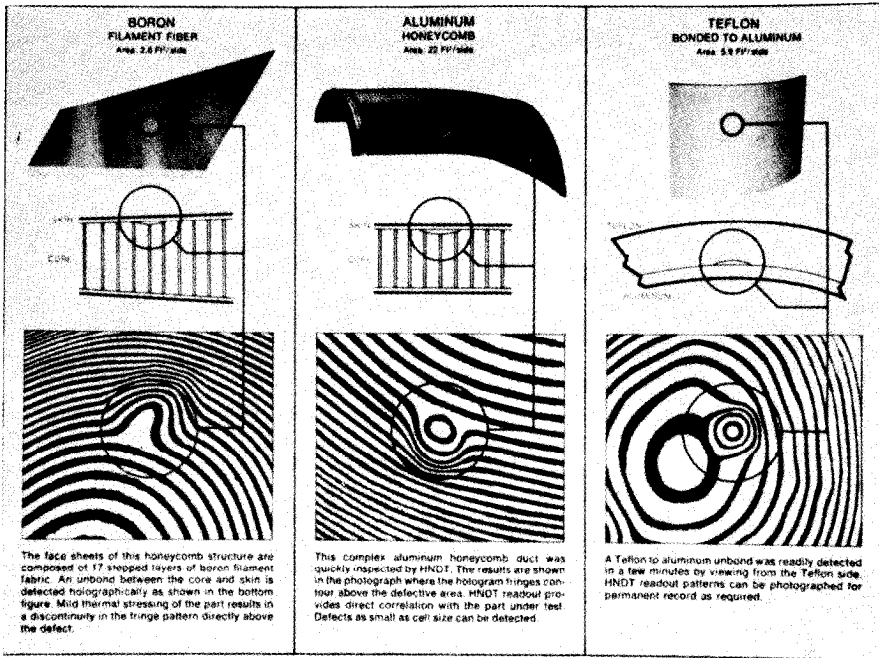

Fig. 23.
Examples of Holographic Non-destructive Testing. (Courtesy of GCO, Ann Arbor, Michigan.)

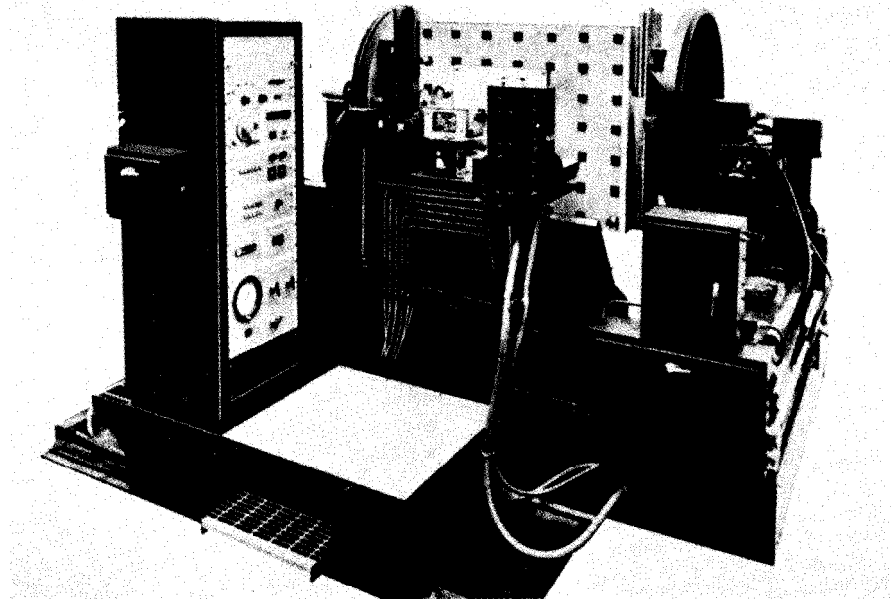

Fig. 24.
Holographic Analyzer Mark II for Sandwich Structures, GCO, Ann Arbor, Michigan.



Fig. 25.
Holographic Contour Map, made by a method initiated by B. P. Hildebrand and K. A. Haines (*Journal, Optical Society of America*, 57, 155, 1967). Improved by J. Varner, University of Michigan, Ann Arbor, 1969.

Figure 23) which are used in aeroplane wings. The smallest welding defect between the aluminum sheets and the honeycomb is safely detected at one glance.

While holographic interferometry is perfectly suited for the detection of very small deformations, with its fringe unit of $1/4000$ mm, it is a little too fine for the checking of the accuracy of workpieces. Here another holographic technique called "contouring" is appropriate. It was first introduced by Haines and Hildebrand, in 1965, and has been recently much improved by J. Varner, also in Ann Arbor, Michigan. Two holograms are taken of the same object, but with two wavelengths which differ by e.g. one percent. This produces beats between the two-fringe system, with fringe spacings corresponding to about $1/40$ mm, which is just what the workshop requires (Figure 25).

From industrial applications I am now turning to another important development in holography. In 1962, just before the "holography explosion" the Soviet physicist Yu. N. Denisyuk published an important paper (13) in which he combined holography with the ingenious method of photography in natural colours, for which Gabriel Lippman received the Nobel Prize in 1908. Figure 26 illustrates Lippmann's method and Denisyuk's idea. Lippmann produced a very fine-grain emulsion, with colloidal silver bromide, and backed the emulsion with mercury, serving as a mirror. Light falling on the emulsion was

How to view the Lippmann type reflection hologram

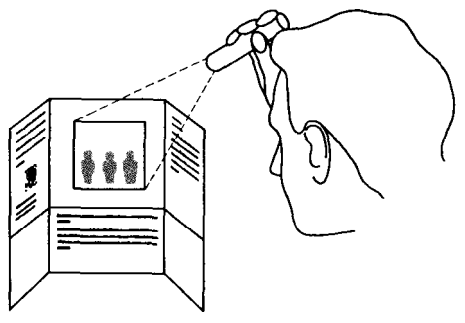

For maximum brightness (due to fulfillment of the Bragg criterion) the hologram shall be illuminated diagonally from the upper righthand corner. An ordinary penlight at a distance of about 25 cm is recommended, see figure. Other approximately point source lighting can be used, such as spotlight, slide projector, or even direct unclouded sunlight.

NB: The hologram ought to be viewed in subdued lighting, and direct overhead light be avoided. The side screens (partly book pages), as indicated in the figure, are good for screening off room light.

THE HOLOGRAM IS NOT REPRODUCED HERE DUE TO COMMERCIAL UNAVAILABILITY.

How the Lippmann type reflection hologram has been constructed

The figure shows how the reference wave comes from one side of the emulsion, the signal wave from the object from the other

side. The dotted line indicates how, at the reconstruction, a wave reflected from the silver layers in the emulsion is obtained, and you see in its extension backwards the object as it was at the registration. (Stroke-Labeyrie, see References.)

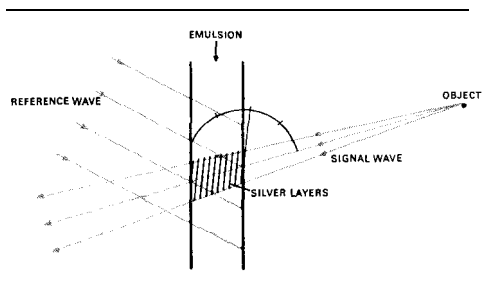

In fact, at the practical registration of a reflection hologram, the signal wave comes from the different points of the illuminated object. In order to have the reconstructed image of the object close to the hologram included, an image of the object has been transported there by means of a special lens. This gives localization of the image closely in front of and behind the hologram.

The hologram is manufactured by McDonnell Douglas Electronics Company, St. Charles, Missouri, USA.

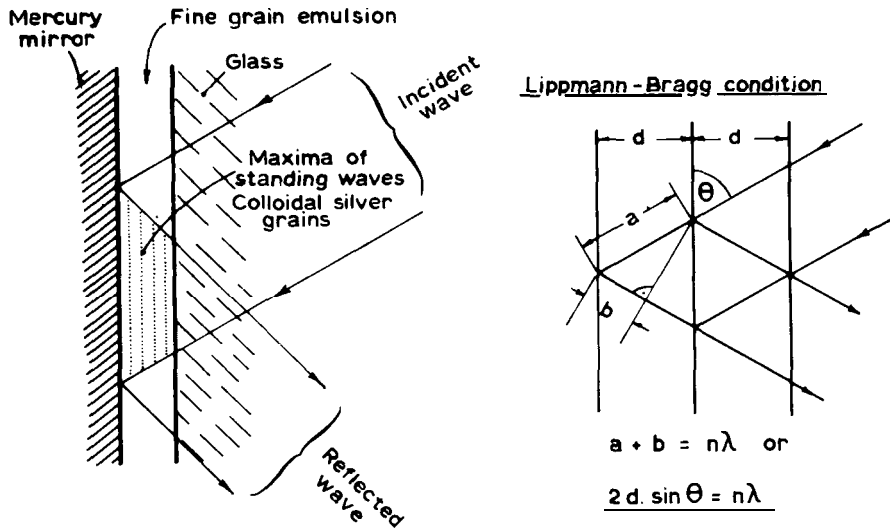

Fig. 26 a. Gabriel Lippmann's method of photography in natural colours.

reflected at the mirror, and produced a set of standing waves. Colloidal silver grains were precipitated in the maxima of the electric vector, in layers spaced by very nearly half a wavelength. After development, the complex of layers, illuminated with white light, reflected only a narrow waveband around the original colour, because only for this colour did the wavelets scattered at the Lippmann layers add up in phase.

Denisjuk's suggestion is shown in the second diagram. The object wave and the reference wave fall in from opposite sides of the emulsion. Again standing waves are produced, and Lippman layers, but these are no longer parallel to the emulsion surface, they bisect the angle between the two wavefronts. If now, and this is Denisjuk's principle, the developed emulsion is illuminated by the

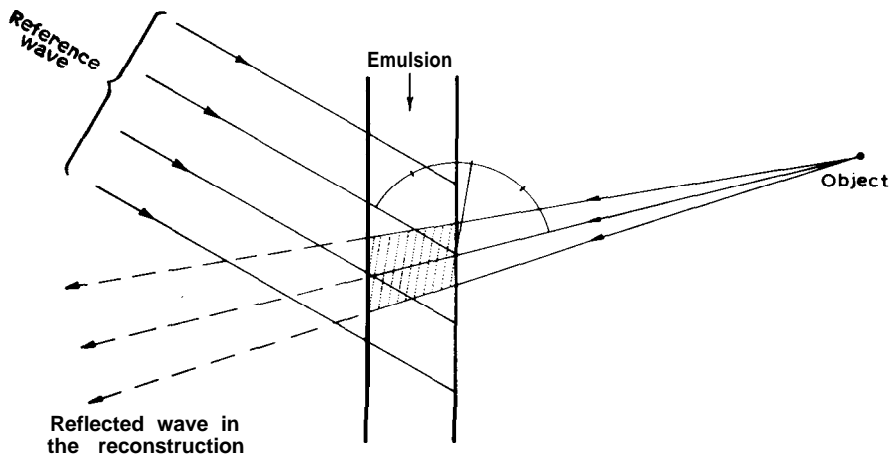

Fig. 26 b. Lippmann-Denisjuk-Stroke Reflection Hologram.

reference wave, the object will appear, in the original position and (unless the emulsion has shrunk) in the original colour.

Though Denisjuk showed considerable experimental skill, lacking a laser in 1962 he could produce only an "existence proof". A two-colour reflecting hologram which could be illuminated with white light was first produced in 1965 by G. W. Stroke and A. Labeyrie (14) and is shown in Figure 27.

Since that time single-colour reflecting holograms have been developed to high perfection by new photographic processes, by K. S. Pennington (15) and others, with reflectances approaching 100 percent, but two; and even more, three-colour holograms are still far from being satisfactory. It is one of my chief preoccupations at the present to improve this situation, but it would take too long, and it would be also rather early to enlarge on this.

An application of holography which is certain to gain high importance in the next years is information storage. I have mentioned before that holography allows storing 100-300 times more printed pages in a given emulsion than ordinary microphotography. Even without utilizing the depth dimension, the factor is better than 50. The reason is that a diffused hologram represents almost ideal coding, with full utilization of the area and of the gradation of the emulsion, while printed matter uses only about 5-10% of the area, and the gradation not at all. A further factor arises from the utilization of the third dimension, the depth of the emulsion. This possibility was first pointed out in an ingenious paper by P. J. van Heerden (16) in 1963. Theoretically it appears possible to store one bit of information in about one wavelength cube. This is far from being practical, but the figure of 300, previously mentioned, is entirely realistic.

However, even without this enormous factor, holographic storage offers important advantages. A binary store, in the form of a checkerboard pattern on microfilm can be spoiled by a single grain of dust, by a hair or by a scratch, while a diffused hologram is almost insensitive to such defects. The holographic store, illustrated in Figure 28, is according to its author L. K. Anderson (17) (1968) only a modest beginning, yet it is capable of accessing for instance any one of 64x64 printed pages in about a microsecond. Each hologram, with a diameter of 1.2 mm can contain about 10^4 bits. Reading out this information

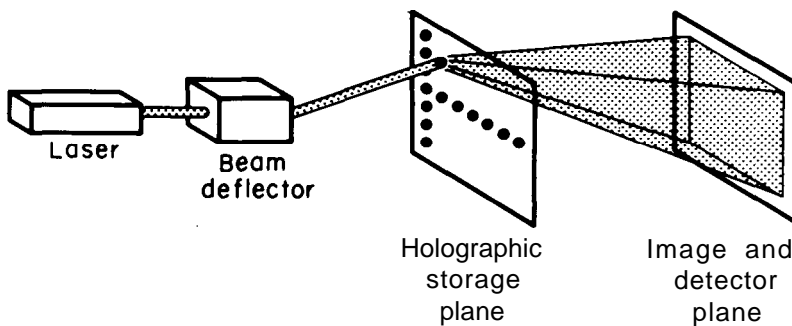

Fig. 28.
Holographic Flying Spot Store. L. K. Anderson and R. J. Collier, Bell Telephone Laboratories, 1968.

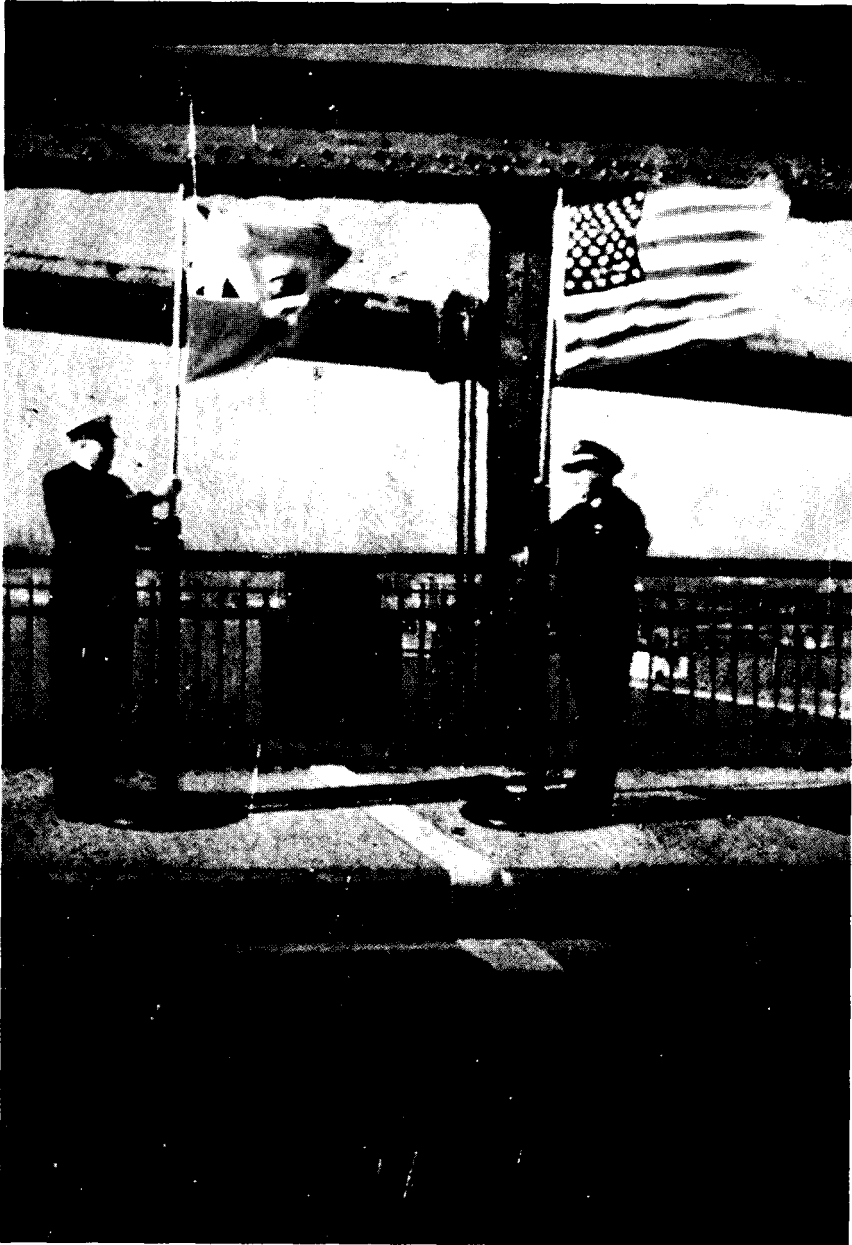

Fig. 27. First two-colour Reflecting Hologram, Reconstructed in White Light. G. W. Stroke and A. Labeyrie, 1965.

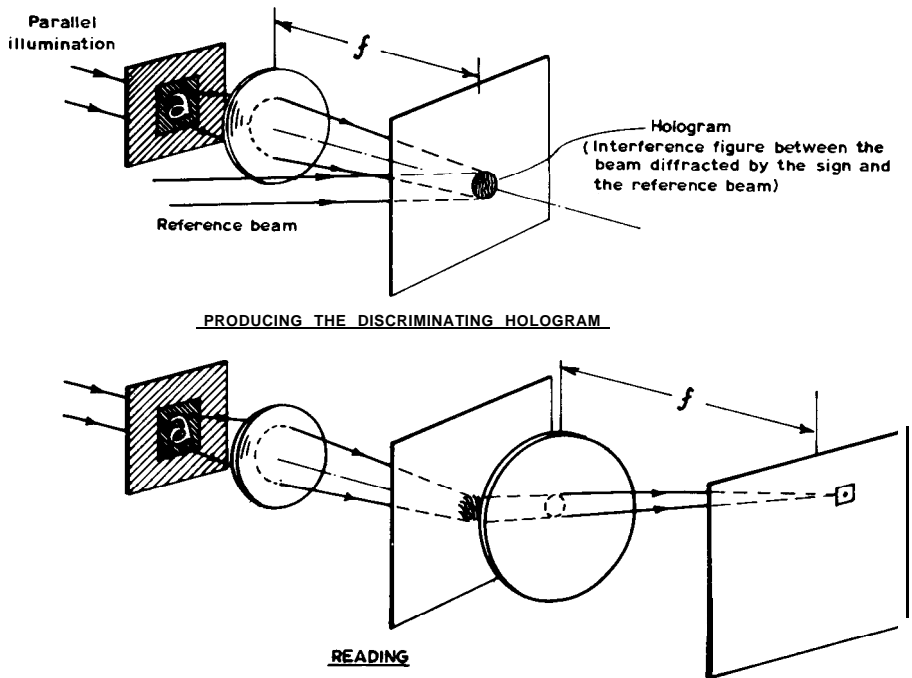

Fig. 29.
The Principle of Character Recognition by Holography.

sequentially in a microsecond would of course require an impossible wave-band, but powerful parallel reading means can be provided. One can confidently expect enormous extensions of these "modest beginnings" once the project of data banks will be tackled seriously.

Another application of holography, which is probably only in an early stage, is pattern and character recognition. I can only briefly refer to the basic work which A. Vander Lugt (18) has done in the field of pattern recognition. It will be sufficient to explain the basic principle of character recognition with the aid of Figure 29.

Let us generalize a little the basic principle of holography. In all previous examples a complicated object beam was brought to interference with a simple or spherical reference beam, and the object beam was reconstructed by illuminating the hologram with the reference beam. But a little mathematics shows that this can be extended to any reference beam *which correlates sharply with itself*. The autocorrelation function is an invariant of a beam; it can be computed in any cross section. One can see at once that a spherical wave correlates sharply with itself, because it issues from a "point". But there are other beams which correlate sharply with themselves, for instance those which issue from a fingerprint, or from a Chinese ideogram, in an extreme case also those which issue from a piece of frosted glass. Hence it is quite possible for instance to translate, by means of a hologram, a Chinese ideogram into its corresponding English sentence and *vice versa*. J. N. Butters and M. Wall in Loughborough University have recently created holograms which

from a portrait produce the signature of the owner, and *vice versa*.⁴ In other words, a hologram can be a fairly universal translator. It can for instance translate a sign which we can read to another which a machine can read.

Figure 29 shows a fairly modest realisation of this principle. A hologram is made of a letter "a" by means of a plane reference beam. When this hologram is illuminated with the letter "a" the reference beam is reconstructed, and can activate for instance a small photocell in a certain position. This, I believe, gives an idea of the basic principle. There are of course many ways of printing letters, but it would take me too long to explain how to deal with this and other difficulties.

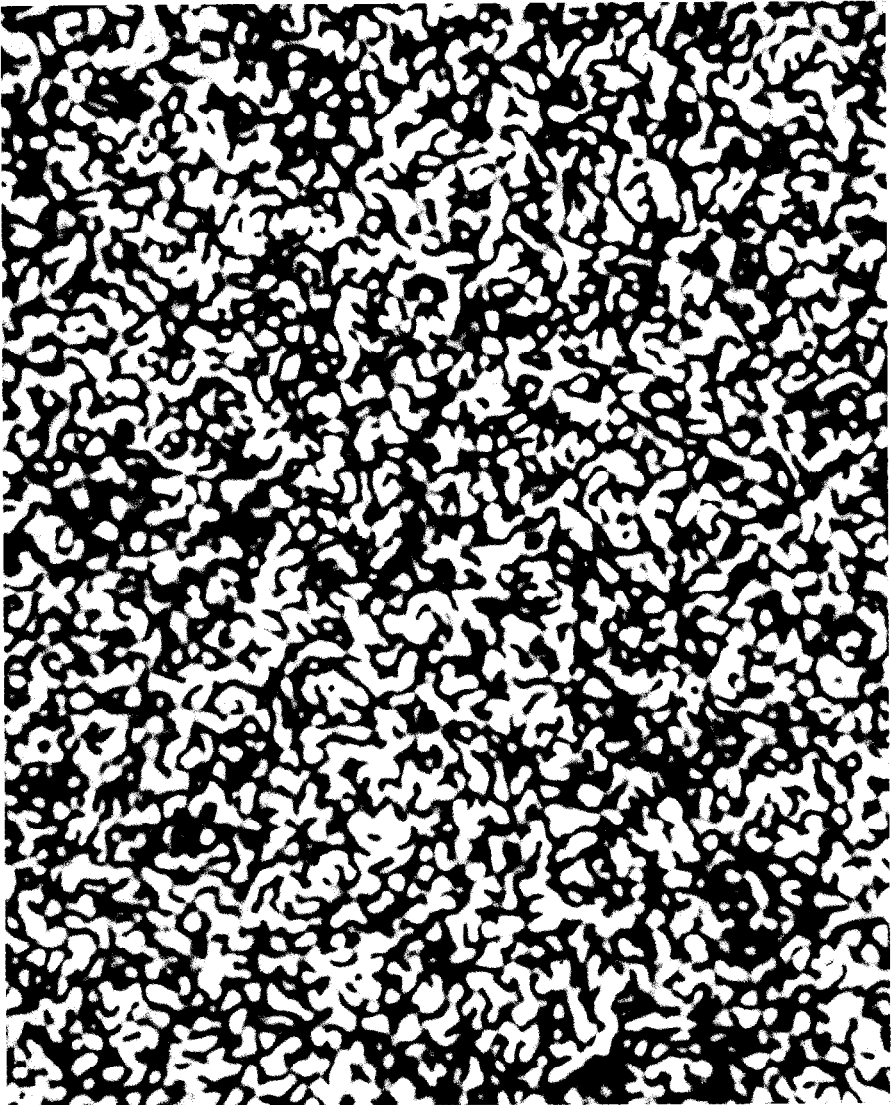

Fig. 30.

Laser Speckle. The appearance of e.g. a white sheet of paper, uniformly illuminated by laser light.

With character recognition devices we have already taken half a step into the future, because these are likely to become important only in the next generation of computers or robots, to whom we must transfer a little more of human intelligence. I now want to mention briefly some other problems which are half or more than half in the future.

One, which is already very actual, is the overcoming of laser speckle. Everybody who sees laser light for the first time is surprised by the rough appearance of objects which we consider as smooth. A white sheet of paper appears as if it were crawling with ants. The crawling is put into it by the restless eye, but the roughness is real. It is called "laser speckle" and Figure 30 shows a characteristic example of it. This is the appearance of a white sheet of paper in laser light, when viewed with a low-power optical system. It is not really noise; it is information which we do not want, information on the microscopic unevenness of the paper in which we are not interested. What can we do against it?

In the case of rough objects the answer is, regrettably, that all we can do is to average over larger areas, thus smoothing the deviations. This means that we must throw a great part of the information away, the wanted with the unwanted. This is regrettable but we can do nothing else, and in many cases we have enough information to throw away, as can be seen by the fully satisfactory appearance of some of the reconstructions from diffuse holograms which I have shown. However, there are important areas in which we can do much more, and where an improvement is badly needed. This is the area of microholograms, for storing and for display. They are made as diffused holograms, in order to ensure freedom from dust and scratches, but by making them diffused, we introduce speckle, and to avoid this such holograms are made nowadays much larger than would be ideally necessary. I have shown recently (19), that advantages of diffuse holograms can be almost completely retained, while the speckle can be completely eliminated by using, instead of a frosted glass, a special illuminating system. This, I hope will produce a further improvement in the information density of holographic stores.

Now let us take a more radical step into the future. I want to mention briefly two of my favourite holographic brainchildren. The first of this is Panoramic Holography, or one could also call it Holographic Art.

All the tree-dimensional holograms made so far extend to a depth of a few meters only. Would it not be possible to extend them to infinity? Could one not put a hologram on the wall, which is like a window through which one looks at a landscape, real or imaginary? I think it can be done, only it will not be a photograph but a work of art. Figure 31 illustrates the process. The artist makes a model, distorted in such a way that it appears perspective, and extending to any distance when viewed through a large lens, as large as the hologram. The artist can use a smaller lens, just large enough to cover both his eyes when making the model. A reflecting hologram is made of it, and illuminated with a strong, small light source. The viewer will see what the plate has seen through the lens; that is to say a scene extending to any distance, in natural colours. This scheme is under development, but considerable work

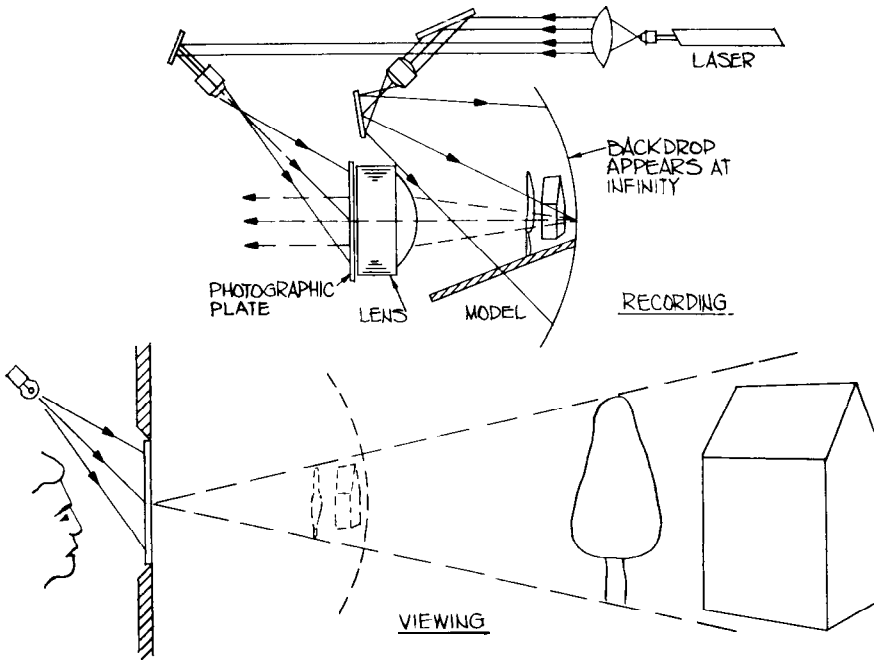

Fig. 31.
Panoramic Holography.

will be needed to make it satisfactory, because we must first greatly improve the reflectance of three-colour holograms.

An even more ambitious scheme, probably even farther in the future, is three-dimensional cinematography, without viewing aids such as Polaroids. The problem is sketched out in Figure 32. The audience (in one plane or two)

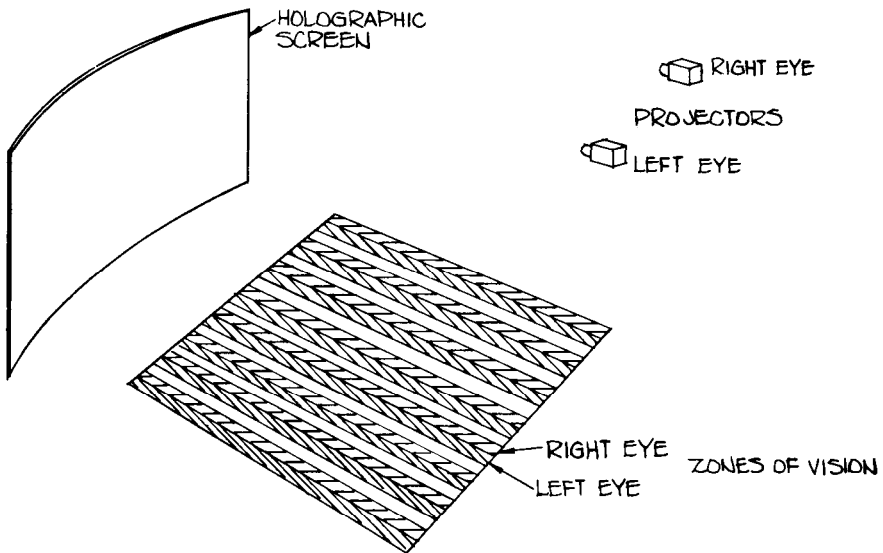

Fig. 32.
3-D Cinematography with Holographic Screen.

is covered by zones of vision, with the width of the normal eye spacing, one for the right eye, one for the left, with a blank space between two pairs. The two eyes must see two different pictures; a stereoscopic pair. The viewer can move his head somewhat to the right or left. Even when he moves one eye into the blank zone, the picture will appear dimmer but not flat, because one eye gives the impression of "stereoscopy by default".

I have spent some years of work on this problem, just before holography, until I had to realise that it is strictly unsolvable with the orthodox means of optics, lenticules, mirrors, prisms. One can make satisfactorily small screens for small theatres, but with large screens and large theatres one falls into a dilemma. If the lenticules, or the like, are large, they will be seen from the front seats; if they are small, they will not have enough definition for the back seats.

Some years ago I realised to my surprise, that holography can solve this problem too. Use a projector as the reference source, and for instance the system of left viewing zones as the object. The screen, covered with a Lippmann emulsion, will then make itself automatically into a very complicated optical system such that when a picture is projected from the projector, it will be seen only from the left viewing zones. One then repeats the process with the right projector, and the right viewing zones. Volume, (Lippmann-Denisyuk) holograms display the phenomenon of directional selectivity. If one displaces the illuminator from the original position by a certain angle, there will be no reflection. We put the two projectors at this angle (or a little more) from one another, and the effect is that the right picture will not be seen by the left eye and vice versa.

There remains of course one difficulty, and this is that one cannot practise holography on the scale of a theatre, and with a plate as large as a screen. But this too can be solved, by making up the screen from small pieces, not with the theatre but with a *model* of the theatre, seen through a lens, quite similar to the one used in panoramic holography.

I hope I have conveyed the feasibility of the scheme, but I feel sure that I have conveyed also its difficulties. I am not sure whether they will be overcome in this century, or in the next.

Ambitious schemes, for which I have a congenital inclination, take a long time for their realisation. As I said at the beginning, I shall be lucky if I shall be able to see in my lifetime the realisation of holographic electron microscopy, on which I have started 24 years ago. But I have good hope, because I have been greatly encouraged by a remarkable achievement of G. W. Stroke (20), which is illustrated in Figure 33. Professor Stroke has recently succeeded in deblurring micrographs taken by Professor Albert Crewe, Chicago, with his scanning transmission electron microscope, by a holographic filtering process, improving the resolution from 5 Angstrom to an estimated 2.5 Angstrom. This is not exactly holographic electron microscopy, because the original was not taken with coherent electrons, but the techniques used by both sides, by A. Crewe and by G. W. Stroke are so powerful, that I trust them to succeed also in the next, much greater and more important step.

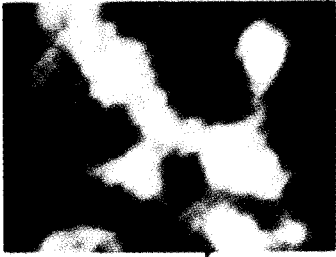
ELECTRON MICROGRAPH
OF
VIRUS

• 5 Å BLUR

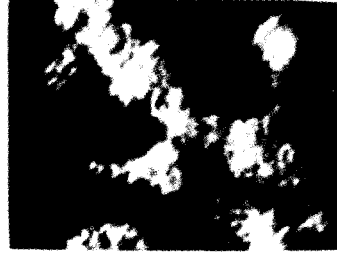
SHARPENED
BY
HOLOGRAPHY

• 2.5 Å RESOLVED

DIFFRACTION



DIFFRACTION

TESTS:
SAME SCALE

Fig. 33.

Scanning Transmission Electron Micrograph. Professor Albert Crewe, University of Chicago, holographically deblurred by Professor G. W. Stroke, 1971. The bottom photographs prove that the effect could not be obtained by hard printing, because some spatial frequencies which appear in the original with reversed phase had to be phase-corrected.

Summing up, I am one of the few lucky physicists who could see an idea of theirs grow into a sizeable chapter of physics. I am deeply aware that this has been achieved by an army of young, talented and enthusiastic researchers, of whom I could mention only a few by name. I want to express my heartfelt thanks to them, for having helped me by their work to this greatest of scientific honours.

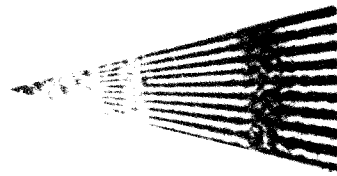
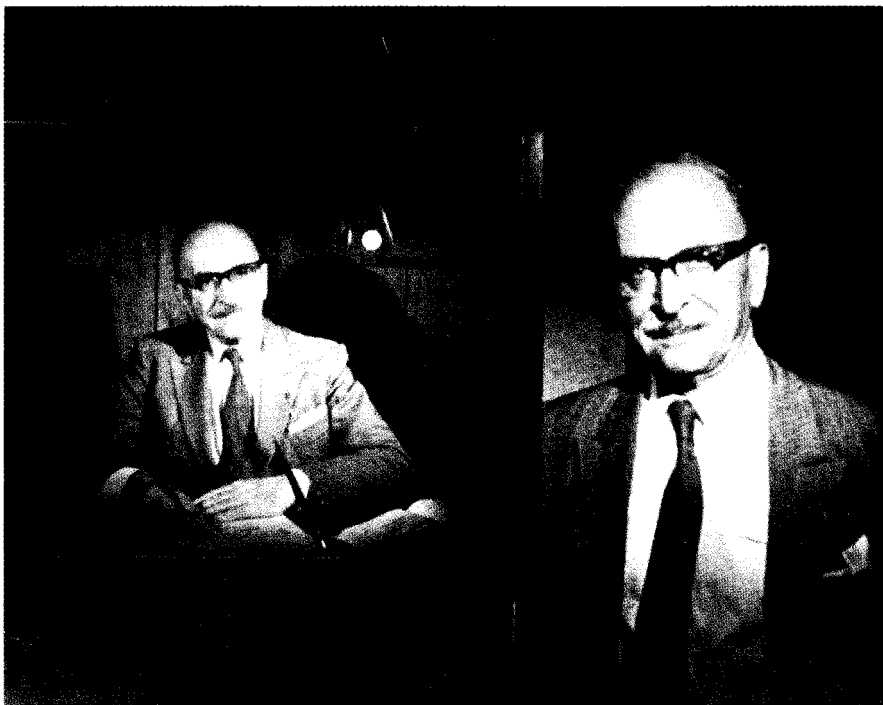

REFERENCES

It is impossible to do justice to the hundreds of authors who have significantly contributed to the development of holography. The number of articles exceeds 2 000, and there are more than a dozen books in several languages.

An extensive bibliography may be found for instance in: T. Kallard, Editor, *Holography* (Optosonic Press, New York, 1969 and 1970)

BOOKS

- Barrekette, E. S., Kock, W. E., Ose, T., Tsujiuchi, J. and Stroke, G. W., Eds. *Applications of Holography* (Plenum Press, New York, 1971)
- Caulfield, H. J. and Sun Lu, *The Applications of Holography* (Wiley Interscience, New York, 1970).
- Collier, R. J., Burckhardt, C. B. and Lin, L. H., *Optical Holography* (Academic Press, New York, 1971).
- DeVelis, J. B. and Reynolds, G. O., *Theory and Applications of Holography* (Addison Wesley, Reading, Massachusetts, 1967).
- Francon, M., *Holographie* (Masson et Cie, Paris, 1969).
- Kiemle, H. und Röss, D., *Einführung in die Technik der Holographic* (Akademische Verlagsgesellschaft, Frankfurt am Main, 1969). *Ibid.* *Introduction to Holographic Techniques* (Plenum Press, 1972, in print).
- Kock, W. E., *Lasers and Holography (An Introduction to Coherent Optics)* (Doubleday & Co., Garden City, NY, Y, 1969).
- Ostrovsky, Yu. I., *Holography* (in Russian) Nauka, Leningrad, 1970).
- Robertson E. R. and Harvey, J. M., Eds., *The Engineering Uses of Holography* (Cambridge University Press, 1970).

- Stroke, G. W., *An Introduction to Coherent Optics and Holography* (Academic Press, New York: 1st Edition, 1966, Second Edition, 1969).
- Viénot, J. Ch., Smigielski, P. et Royer, H., *Holographie Optique (Developments, Applications)* (Dunod, Paris, 1971).
1. Gabor, D., "A New Microscopic Principles", *Nature* 161, No. 4098, 777-778 (1948).
Gabor, D., "Microscopy by Reconstructed Wavefronts", *Proc. Roy. Soc. (London)* A 197, 454-487 (1949).
Gabor, D., "Microscopy by Reconstructed Wavefronts: II", *Proc. Phys. Soc. (London)* 64 (Pt. 6) No. 378 B, 449-469 (1951).
 2. Rogers, G. L., "Experiments in Diffraction Microscopy", *Proc. Roy. Soc. (Edinburgh)* 63 A, 193 (1952).
 3. Baez, A., "Resolving Power in Diffraction Microscopy", *Nature*, 169, 963-964 (1952).
 4. El-Sum, H. M. A. and Kirkpatrick, P., "Microscopy by Reconstructed Wavefronts" *Phys. Rev.*, 85, 763 (1952).
 5. Gabor, D. and Goss, W. P., "Interference Microscope with Total Wavefront Reconstruction", *J. Opt. Soc. Am.* 56, 849-858 (1966).
 6. Cutrona, L. J., Leith, E. N., Porcello, L. J. and Vivian, W. E., "On the Application of Coherent Optical Processing Techniques to Synthetic Aperture Radar", *Proc. IEEE*, 54, 1026-1032 (1966).
 7. Leith, E. N. and Upatnieks, J., "Wavefront Reconstruction with Continuous Tone Transparencies", *J. Opt. Soc. Am.* 53, 522 (1963) (Abstract).
Leith, E. N. and Upatnieks, J., "Wavefront Reconstruction with Continuous-Tone Objects", *J. Opt. Soc. Am.* 53, 1377-1381 (1963).
Leith, E. N., and Upatnieks, J., "Wavefront Reconstruction with Diffused Illumination and Three-Dimensional Objects" *J. Opt. Soc. Amer.*, 54, 1295 (1964).
 8. An early reference is:
Stroke, G. W., "Theoretical and Experimental Foundations of High-Resolution Optical Holography" (Presented in Rome on 14 September 1964) in Vol. II, pp. 53-63 of *Publicazioni IV Centenario della Nascita di Galileo Galilei* (G. Barbera, Firenze, 1966).
 9. Knox, C. and Brooks, R. E., "Holographic Motion Picture Microscopy" *Proc. Roy. Soc. (London)*, B 174, 115-121 (1969).
 10. Heflinger, L. O., Wuerker, R. F. and Brooks, R. E., *J. Appl. Physics*, 37, No. 2, 642-649 (February 1966).
 11. Burch, J. M., "The Application of Lasers in Production Engineering", *Production Engineer*, 44, 431-442 (1965).
Powell, R. L. and Stetson, K. A., "Interferometric Vibration Analysis by Wavefront Reconstruction", *J. Opt. Soc. Am.* 55, 1593-1598 (1965).
Stroke, G. W. and Labeyrie, A. E., "Two-Beam Interferometry by Successive Recording of Intensities in a Single Hologram", *Appl. Physics Letters*, 8, No. 2, 42-44 (15 January 1966).
 12. Stetson, K. A., Thesis (under direction of E. Ingelstam), Royal Institute of Technology, Stockholm (1969).
 13. Denisyuk, Yu. N., "Photographic Reconstruction of the Optical Properties of an Object in its Own Scattered Radiation", *Dokl. Akad. Nauk. SSR*, 144, 1275-1278 (1962).
 14. Stroke, G. W. and Labeyrie, A. E., "White-Light Reconstruction of Holographic Images using the Lippmann-Bragg Diffraction Effect", *Physics Letters*, 20, 368-370 (1966).
 15. Pennington, K. S. and Harper, J. S., "Techniques for Producing Low-Noise, Improved-Efficiency Holograms", *Appl. Optics*, 9, 1643-1650 (1970).
 16. Van Heerden, P. J., "A New Method of Storing and Retrieving Information", *Appl. Optics*, 2, 387-392 (1963).

17. Anderson, L. K., "Holographic Optical Memory for Bulk Data Storage", Bell Lab Rep. 46, 318 (1968).
18. Vander Lugt, A., "Signal Detection by Complex Spatial Filtering", IEEE Trans. on Information Theory, IT-10, 139-145 (1964).
19. Gabor, D., "Laser Speckle and its Elimination", IBM J. of Res. and Dev. 14, 509-514 (Sept. 1970).
20. Stroke, G. W., "Image Deblurring and Aperture Synthesis Using 'A Posteriori' Processing by Fourier-Transform Holography", *Optica Acta*, 16, 401-422 (1969).
Stroke, G. W. and Halioua, M., "Attainment of Diffraction-Limited Imaging in High-Resolution Electron Microscopy by 'A Posteriori' Holographic Image Sharpening", *Optik* (1972) (in print).